

T-Series 288W Driver

24VDC DIMMABLE CLASS 2 MULTI-OUTPUT LED DRIVER

Product Code: T288L24DC

iLED SKU#: 3940

Magnitude's T288L24DC is a multi-output Class 2 LED dimmable driver. It is equipped with two push-to-reset breakers, one on each output, protecting both the load and driver. Encased in a high-quality NEMA 3R metal case enclosure, that includes 5 knockouts to enable easy installation. All of our T-Series LED Drivers are dimmable with any standard MLV TRIAC dimmer.

Features

Class 2, ETL Listed, Certified to CSA Standard

Wiring compartment with 5 knockouts for clean, easy installation

Dimmable with standard MLV/TRIAC (leading edge) dimmer switch

Push-to-reset circuit breakers

Nema 3R Enclosure, for Commercial and Residential use

Specifications

50% minimum load per output, not to exceed 85% load per output

Max Load	96W per port (X3)
Input Voltage	120V AC
Input Current at Max Load	3.4A
Output Voltage	24V DC
Output Current at Max Load	4A per port
Open Circuit Output Voltage	24.5V DC
Efficiency at Max Load	80%
Power Factor	0.9
Coil Former	Double Section Bobbin
Max Ambient Temperature	-30°C to 40°C
Min Installation Space btw Drivers	5 inches
Thermal Class	B130°C
Leads Primary	Screw Terminal Blocks
Leads Secondary	Screw Terminal Blocks
Dimensions (inch)	11.33" x 4.73" x 4.26"
Weight	15 lbs

Wiring Diagram

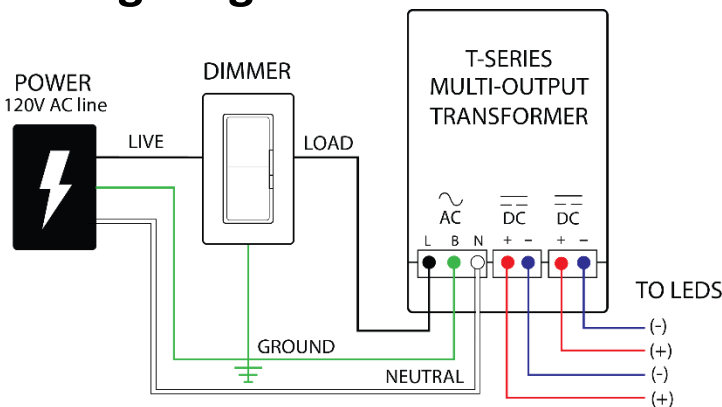

BEFORE YOU BEGIN

Note: This dimmable transformer requires a **compatible magnetic low voltage (MLV) wall dimmer** for proper operation. Do **not** use with a PWM controller. See the full list of approved dimmers recommended by Magnitude Inc. and Inspired LED. This driver is to be installed by a qualified electrician in accordance with Article 450 of the N.E.C.. It must be mounted in a well-ventilated area free from explosive gasses and vapors. Proper operation requires a free flow of air.

Precautions Before Installing

Check the label to ensure the driver has the proper input voltage and wattage for the job. Check the wire markings to ensure they match the wiring diagram below.

Input Connections/Grounding

Remove the wiring compartment knockouts and install strain reliefs. With power turned off, route the input wires through the knockout. Connect live wire from dimmer to terminal marked (L), neutral wire to terminal marked (N), and ground wire to terminal marked (B). The transformer case **MUST** be grounded in accordance with National Electrical Code.

Output Connections

Bring the wires from light fixture(s) through other open knockouts and connect to screw terminal outputs. Connect positive wires to terminals marked (+), and negative wires to terminals marked (-). For optimal performance it is recommended that each output is connected to a 50% minimum load, not to exceed 85% on any one channel.

Caution: Each terminal block is protected with an independent circuit breaker and must be wired independently. Do not crosswire!

Mounting

Select a location capable of supporting the weight of the driver. Use the two keyholes in the driver case to mount using suitable screws. It is recommended that the driver be mounted vertically with the wiring compartment pointing down.

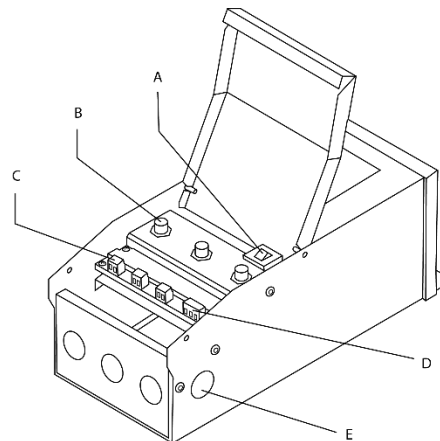

A	Primary Circuit Breaker
B	Secondary Circuit Breaker
C	Output Terminal Blocks
D	Input Terminal Block
E	Wiring Knockouts